







# 3.1 Sangles d'arrimage

## Sangles en ceinture 22/25 mm

Idéale pour une utilisation en V.U.L.









### ► Tendeur





1 - Tendeur	2 - Couleur / Longueur	3 - Impression label et sangle	4 - Options	Code
				
LC 800 daN*, STF 390 daN* zingué jaune: 71 234; induction poudre bleue: 560 438-10				
				
LC 1300 daN*, STF 400 daN* zingué blanc: 360 013-10 zingué jaune: 77 036				
				
LC 2000 daN*, STF 340 daN* 71 036				
				
LC 600 daN* 522406				
				
LC 500 daN* 71 012				
				
LC 600 daN* 522406				511264 + Code

\* Donnée en cerclage

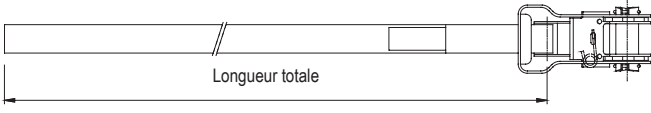



### ► Couleur / Longueur

✓	2 - Couleur / Longueur	3 - Impression label et sangle	4 - Options	Code			
							
Bleu	Rouge	Gris	Noir	Olive	Orange	Vert	
							
Jaune							Couleur
Toutes les couleurs ne sont pas disponibles pour certains tendeurs							
 <p>Longueur totale</p>							
Longueur totale en mm							Longueur totale

### ► Impression de la sangle et du label

✓	✓	3 - Impression label et sangle	4 - Options	Code
				
Exemples d'impressions de sangle et de labels personnalisés				
Votre impression personnalisée sur la partie longue (Impression allsafe possible)				Impression sangle
Sans impression sur la sangle				Sans impression
Votre label personnalisé				Impression label

## ► Options

✓	✓	✓	4 - Options	Code
				
Protection sous le tendeur	Protection du label	Fourreau de protection caoutchouc bleu	Fourreau de protection polyester violet	

## ► Exemple de Code pour la commande

511264	-	71036	-	Oliv	-	3800	-	Impression label	-	Protection du label
25 mm Sangle en ceinture		Tendeur		Couleur		Longueur totale		Impression sangle		Options

LC : La capacité de charge de votre sangle prend en compte la capacité de charge du plus faible des éléments, tendeur ou embout.

## ■ ■ ■ Accessoires

		
Rouleau anti-glisse $\mu = 0,5 - 0,6$ 8 mm épaisseur, 0,25 x 5,0 m: 560088-10 3 mm épaisseur, 0,15 x 20,0 m: 560460-10	Patin anti-glisse $\mu = 0,5 - 0,6$ e. 100 x 200 x 8 mm 560381-10	coin plastique de protection 560261-10



## 3.1 Sangles d'arrimage

### ■ ■ ■ Sangles en ceinture 35 mm

La taille intermédiaire idéale – maintenant aussi en sangle en ceinture.





#### ► Tendeur





1 - Tendeur	2 - Couleur / Longueur	3 - Impression label et sangle	4 - Options	Code
				
LC 3000 daN*, STF 450 daN*	LC 450 daN*			511387
77 131	71 039			+ Code

\* Donnée en cerclage

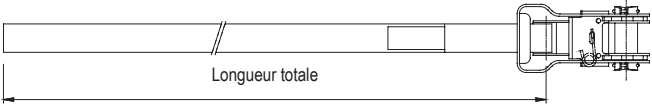



#### ► Couleur / Longueur

✓	2 - Couleur / Longueur	3 - Impression label et sangle	4 - Options	Code
				
Bleu	Rouge	Olive	Orange	Couleur
Toutes les couleurs ne sont pas disponibles pour certains tendeurs				
				
Longueur totale en mm				Longueur totale

#### ► Impression de la sangle et du label

✓	✓	3 - Impression label et sangle	4 - Options	Code
				
Exemples d'impressions de sangle et de labels personnalisés				
Votre impression personnalisée sur la partie longue (Impression allsafe possible)				Impression sangle
Sans impression sur la sangle				Sans impression
Votre label personnalisé				Impression label

## ► Options

✓	✓	✓	4 - Options	Code
				
Protection sous le tendeur	Protection du label	Fourreau de protection caoutchouc bleu	Fourreau de protection polyester violet	

## ► Exemple de Code pour la commande

512003	-	71039	-	Oliv	-	3800	-	Impression sangle	-	Protection du label
25 mm Sangle en ceinture		Tendeur		Couleur		Longueur totale		Impression sangle		Options

LC : La capacité de charge de votre sangle prend en compte la capacité de charge du plus faible des éléments, tendeur ou embout.

## ■ ■ ■ Accessoires

		
Rouleau anti-glisse $\mu = 0,5 - 0,6$ 8 mm épaisseur, 0,25 x 5,0 m: 560088-10 3 mm épaisseur, 0,15 x 20,0 m: 560460-10	Patin anti-glisse $\mu = 0,5 - 0,6$ e. 100 x 200 x 8 mm 560381-10	coin plastique de protection 560261-10

# 3.1 Sangles d'arrimage

## Sangles en ceinture 45/50 mm

La taille parfaite pour le PL – maintenant aussi en sangle en ceinture.







### ► Tendeur





1 - Tendeur	2 - Couleur / Longueur	3 - Impression label et sangle	4 - Options	Code
				
LC 1000 daN, STF 150 daN 71 265				
				
LC 1650 daN, STF 165 daN 71 016				
				
LC 2500 daN, STF 250 daN 71 056				
				
LC 2500 daN, STF 400 daN 71 179				
				
LC 2500 daN, STF 500 daN 77 179				
			Inox!	
LC 400 daN 71 299				
				
LC 750 daN 71 014				
				
LC 1150 daN 71 300				
				
LC 500 daN 71 010				
				
LC 350 daN 71 303				512004 + Code

\* Donnée en cerclage

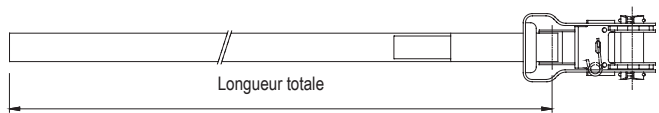



### ► Couleur / Longueur

✓	2 - Couleur / Longueur	3 - Impression label et sangle	4 - Options	Code			
							
Bleu	Rouge	Gris	Noir	Olive	Orange	Vert	Couleur
Toutes les couleurs ne sont pas disponibles pour certains tendeurs							
 <p>Longueur totale</p>							
Longueur totale en mm							Longueur totale

## ► Impression de la sangle et du label

✓	✓	3 - Impression label et sangle	4 - Options	Code
				
Exemples d'impressions de sangle et de labels personnalisés				
Votre impression personnalisée sur la partie longue (Impression allsafe possible)				Impression sangle
Sans impression sur la sangle				Sans impression
Votre label personnalisé				Impression label

## ► Options

✓	✓	✓	4 - Options	Code
				
Protection sous le tendeur	Protection du label	Fourreau de protection caoutchouc bleu	Fourreau de protection polyester violet	

## ► Exemple de Code pour la commande

511264	-	71036	-	Oliv	-	3800	-	Impression label	-	Protection du label
25 mm Sangle en ceinture		Tendeur		Couleur		Longueur totale		Impression sangle		Options

LC : La capacité de charge de votre sangle prend en compte la capacité de charge du plus faible des éléments, tendeur ou embout.

## ■ ■ ■ Accessoires

		
Rouleau anti-glisse $\mu = 0,5 - 0,6$ 8 mm épaisseur, 0,25 x 5,0 m: 560088-10 3 mm épaisseur, 0,15 x 20,0 m: 560460-10	Patin anti-glisse $\mu = 0,5 - 0,6$ e. 100 x 200 x 8 mm 560381-10	coin plastique de protection 560261-10