

Your customized track. Compose it yourself:



▶ Total length

Compose your ready-to-install Airline track. We manufacture the tracks to any length required.

▶ Mounting holes and starting point



Design the tracks with the appropriate mounting holes and the pitch required.

▶ Shape of the ends



Design the end of the track to fit the interior.

▶ Customization

allsafe is specialized in the design and production of cabin and cargo seat tracks. A state of the art machinery allows us to offer you a broad range of customized tracks.

Seat and cargo tracks which can be supplied in lengths up to 6.000 mm. Our tracks are not surface treated. Material used is aluminium 7075T6511, 7075T73510 or 7075T73511.

Compose your ready-to-install track. We manufacture the tracks to any length required. Design the tracks with the appropriate mounting holes and individual ends required.

According to your needs we can offer various kind of machining as well as surface treatments (e.g. anodizing according to MIL-A-8625 or primer coating).



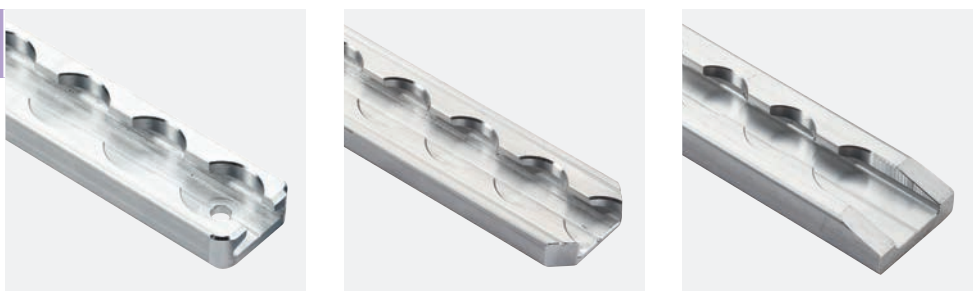
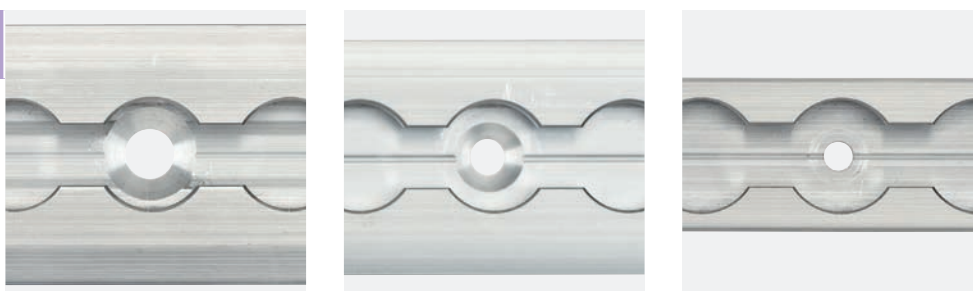

Tracks according to your specification?

- With our inhouse development and manufacturing we can develop individual tracks according to your specification needs. Just ask us!

You need assemblies of seat tracks with special fittings for the duplication of a cabin or cargo floor, e.g. for ballistic protection, VIP equipment or EMS flooring?

- allsafe has developed a range of high strength products allowing quick and easy installation and removal of such elements and can supply complete assemblies, including all necessary surface treatments.

You need seat tracks for mock-ups, assembly stations or transport purposes?







- Please take a look at our pages 14 to 16. We can offer you a wide range of economical aluminium tracks for these purposes.

Seat and Cargo Tracks

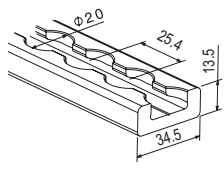
Seat Track conforms to AS33601 or ISO 7166

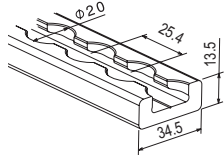
Ultimate load: vertical 26.67 kN/6000 lbf with Single Stud fitting, 44.45 kN/10000 lbf with double stud fitting*

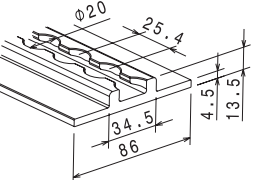
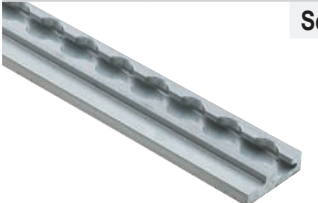
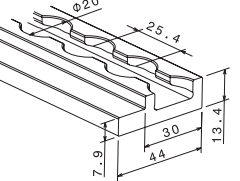
► Profile and length

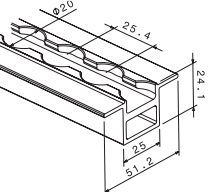
1 - Profile / Length	2 - Starting dimension	3 - Mounting holes	4 - Ends		
		Info	Material	Weight	Order code
	Seat track, rectangular 	For new designs	Aluminium 7075T73511, finish natural, surface treatment available upon request	890 grs/m	120237 rectangular Length mm xxxx (100-6 000 mm)
	Seat track, rectangular classic 		Aluminium 7075T6511, finish natural, surface treatment available upon request	890 grs/m	71009 rectangular classic Length mm xxxx (100-6 000 mm)
	Seat track, flange 		Aluminium 7075T73511, finish natural, surface treatment available upon request	1534 grs/m	120416 flange Length mm xxxx (100-3 400 mm)
	Seat track, one flange 		Aluminium 7075T79511, finish natural, surface treatment available upon request	1010 grs/m	120414 one flange Length mm xxxx (100-1 700 mm)
	Seat track, hollow 		Aluminium 7075T73511, finish natural, surface treatment available upon request	880 grs/m	120247 hollow Length mm xxxx (100-3 000 mm)

* fitting according to AS33601 and when track is installed with 10/32 flush screws every 25.4 mm on hole centers, otherwise track load capacity is depending on type and spacing of fasteners used.

If you need seat tracks for mock-ups, assembly stations or transport purposes please have a look at pages 14 to 16

▶ Starting point

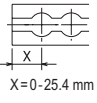
✓	2 - Starting dimension	3 - Mounting holes	4 - Ends	Order code
				
If not indicated otherwise, the starting point X = 0 mm				

▶ Mounting holes

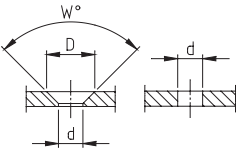
✓	✓	3 - Mounting holes	4 - Ends	Order code																																
		<table border="1"> <thead> <tr> <th></th> <th>S 5.5</th> <th>S 6.6</th> <th>D 5.5</th> <th>D 6.6</th> <th>D 8.5</th> <th>N 5</th> <th>individual</th> </tr> </thead> <tbody> <tr> <td>W</td> <td>100°</td> <td>100°</td> <td></td> <td></td> <td></td> <td>120°</td> <td>90° / 100°</td> </tr> <tr> <td>D</td> <td>10.7</td> <td>13.0</td> <td></td> <td></td> <td></td> <td>12.0</td> <td>10.0 - 20.0</td> </tr> <tr> <td>d</td> <td>5.1</td> <td>6.6</td> <td>5.5</td> <td>6.6</td> <td>8.5</td> <td>5.05</td> <td>5.0 - 9.0</td> </tr> </tbody> </table>		S 5.5	S 6.6	D 5.5	D 6.6	D 8.5	N 5	individual	W	100°	100°				120°	90° / 100°	D	10.7	13.0				12.0	10.0 - 20.0	d	5.1	6.6	5.5	6.6	8.5	5.05	5.0 - 9.0		
	S 5.5	S 6.6	D 5.5	D 6.6	D 8.5	N 5	individual																													
W	100°	100°				120°	90° / 100°																													
D	10.7	13.0				12.0	10.0 - 20.0																													
d	5.1	6.6	5.5	6.6	8.5	5.05	5.0 - 9.0																													
Please select the type of mounting holes (S = Countersunk screw, D = Cylindric hole, N = Countersunk rivet)				e.g.: S 5.5																																

▶ Pitch of mounting holes

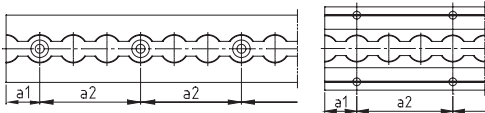
✓	✓	3 - Mounting holes	4 - Ends	Order code
			<p>Ultimate load with fitting according to AS33601 and when track is installed with 10/32 flush screws every 25.4 mm on hole centers, otherwise track load capacity is depending on type and spacing of fasteners used.</p>	
Please specify the pitch of the mounting holes a1 and a2				a1-xx / a2-xx

▶ Shape of ends

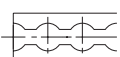
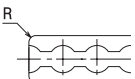
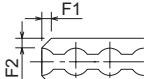
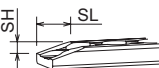
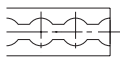
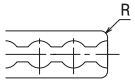
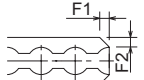
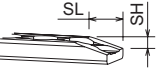
✓	✓	✓	4 - Ends	Order code
				A – straight A – R-xx A – F1-xx F2-xx A – SH-xx SL-xx
Please select the shape of the beginning of the track (max. radius or max. F2 = half of track width in mm)				
				E – straight E – R-xx E – F1-xx F2-xx E – SH-xx SL-xx
Please select the shape of the end of the track (max. radius or max. F2 = half of track width in mm)				

▶ Sample order code

Seat track flange - 1497 - S 5.5 - a1-25.4/a2-50.8 - A-straight - E-straight



Seat and Cargo Tracks Medium Duty

Please note:

Medium Duty Seat Track not entirely conforming with AS33601 or ISO 7166

Ultimate load:* vertical 17.78 kN / 4000 lbf horizontal 8.89 kN / 2000 lbf – For compatibility studs please ask!

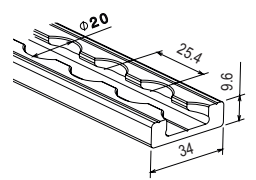
► Profile and length (100 to 6000 mm)

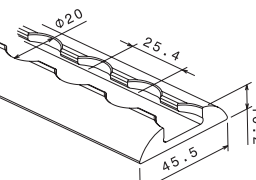
1 - Profile / Length	2 - Starting dimension	3 - Mounting holes	4 - Ends		
		Info	Material	Weight	Order code
	Seat track MD, rectangular		Aluminium 7075T6511 or T73511, finish natural, surface treatment available upon request	590 grs/m	71202 MD rectangular Length mm xxxx
	Seat track MD, semicircular		Aluminium 7075T6511 or T73511, finish natural, surface treatment available upon request	800 grs/m	71201 MD semicircular Length mm xxxx

* when track is installed with 10/32 flush screws every 25.4 mm on hole centers, otherwise track load capacity is depending on type and spacing of fasteners used.

▶ Starting point

✓	2 - Starting dimension	3 - Mounting holes	4 - Ends	Order code
				
If not indicated otherwise, the starting point X = 0 mm				

▶ Mounting holes

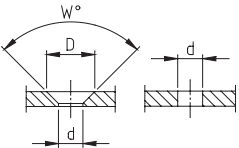
✓	✓	3 - Mounting holes	4 - Ends	Order code																																
		<table border="1"> <thead> <tr> <th></th> <th>S 5.5</th> <th>S 6.6</th> <th>D 5.5</th> <th>D 6.6</th> <th>D 8.5</th> <th>N 5</th> <th>individual</th> </tr> </thead> <tbody> <tr> <td>W</td> <td>100°</td> <td>100°</td> <td></td> <td></td> <td></td> <td>120°</td> <td>90° / 100°</td> </tr> <tr> <td>D</td> <td>10.7</td> <td>13.0</td> <td></td> <td></td> <td></td> <td>12.0</td> <td>10.0 - 20.0</td> </tr> <tr> <td>d</td> <td>5.1</td> <td>6.6</td> <td>5.5</td> <td>6.6</td> <td>8.5</td> <td>5.05</td> <td>5.0 - 9.0</td> </tr> </tbody> </table>		S 5.5	S 6.6	D 5.5	D 6.6	D 8.5	N 5	individual	W	100°	100°				120°	90° / 100°	D	10.7	13.0				12.0	10.0 - 20.0	d	5.1	6.6	5.5	6.6	8.5	5.05	5.0 - 9.0		
	S 5.5	S 6.6	D 5.5	D 6.6	D 8.5	N 5	individual																													
W	100°	100°				120°	90° / 100°																													
D	10.7	13.0				12.0	10.0 - 20.0																													
d	5.1	6.6	5.5	6.6	8.5	5.05	5.0 - 9.0																													
Please select the type of mounting holes (S = Countersunk screw, D = Cylindric hole, N = Countersunk rivet)				e.g.: S 5.5																																

▶ Pitch of mounting holes

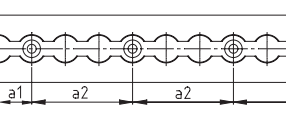
✓	✓	3 - Mounting holes	4 - Ends	Order code
			<p>Ultimate load with fitting according to AS33601 and when track is installed with 10/32 flush screws every 25.4 mm on hole centers, otherwise track load capacity is depending on type and spacing of fasteners used.</p>	
Please specify the pitch of the mounting holes a1 and a2				a1-xx / a2-xx

▶ Shape of ends

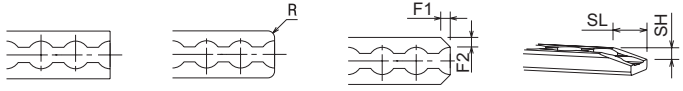
✓	✓	✓	4 - Ends	Order code
				A – straight A – R-xx A – F1-xx F2-xx A – SH-xx SL-xx
Please select the shape of the beginning of the track (max. radius or max. F2 = half of track width in mm)				
				E – straight E – R-xx E – F1-xx F2-xx E – SH-xx SL-xx
Please select the shape of the end of the track (max. radius or max. F2 = half of track width in mm)				

▶ Sample order code

Seat track MD rectangular - 1497 - S5 - a1-25.4/a2-50.8 - A-straight - E-straight

